

INTRODUCTION

After disasters such as hurricanes, tornadoes, straight line winds, etc, we often have the opportunity to go and serve others by helping them clean up debris left as the results of these catastrophes. The process for cleaning up after a disaster is governed by local and state regulations. Things that you can do in one locale may not be applicable in another. It is relevant that the Incident Commander and the Command Center are in contact with local authorities to insure that the rules and regulations for the affected area are understood and followed.

Just as with other DR activities, the Property Release Form must be completed and signed by the property owner. The site should also be looked at by the Assessors.

Loss of personal possessions is an important issue. As you work be sensitive to the feeling loss or damage to the owners property.

PROCESS FOR CHAINSAW WORK

1. Report to the command center, White cap when arriving at the site.
2. Login on the daily report form with the information requested, i.e. name, home, cell phone #.
3. Obtain maps and other information from the area.
4. Get information about:
 - a. receiving work tickets
 - b. rules for placing debris for removal
 - c. location of medical facilities.
5. When you arrive at the work site:
 - a. Always check to see if the occupant of the residence is at home.
 - If the occupant is not at home and you have a signed release form, you can begin to work.
 - b. Inform the occupant of what you are planning to do, ask them if it is permissible to take pictures.
 - c. Assign one team member (if you do not have a chaplain) to talk to the occupant about their needs, LISTEN to what they want to tell you. Sometimes this is the most important part of the visit.
 - d. Leave the occupant with a bible, tract, local church information, and the address/phone number of the command center.
 - e. Complete the "Release" form when finished. "
 - f. If there is a need for follow up with the occupant, note on the form and let the command center know when you turn the tickets in.
6. At the end of the day, group your completed forms by area and give them to the White cap.
7. Be available to answer any questions that might arise about the forms, discuss any unusual circumstances with the Blue cap

8. Get new assignments each morning at control center.
9. Carry tarps and bottled water to handout if needed.

SAFETY OF PERSONNEL IS ALWAYS NUMBER ONE
Preventing further damage to property is secondary.

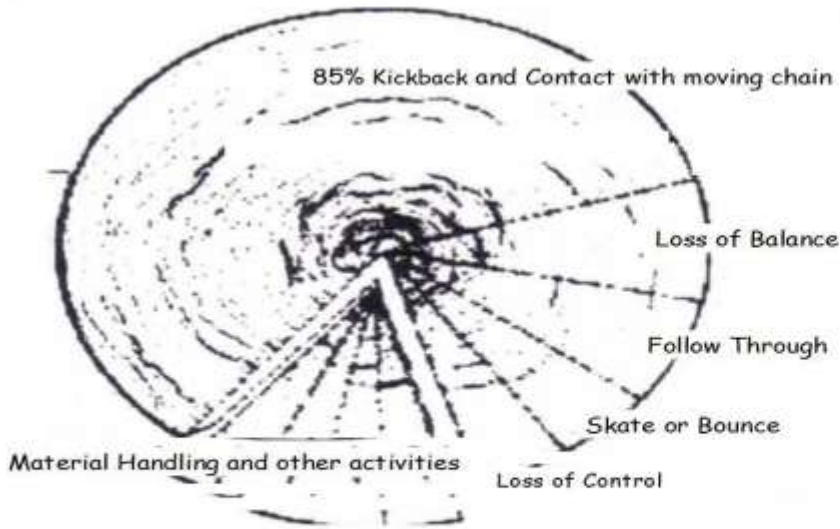

A. THE INHERENT DANGERS

Natural disasters come in a variety of forms. Floods, tornadoes, earthquakes, and grassfires are but just a few events that the chainsaw team may be called on to respond to. The cautious volunteer knows that danger lurks in each event long after the winds and waters have subsided. Snakes, confused pets, infectious waters and plants, downed power line and structurally damaged buildings all add to the scenario of danger in the field for the volunteer. Common sense must prevail when going into the field to conduct chainsaw work. It matters little to safely operate a chainsaw if you injure yourself by some other means. You will not be able to do much ministry when you become the one who needs ministering to.

Fatigue is a common malady among volunteers especially those who are operating chainsaws, climbing onto roofs or pulling limbs. Working several days in sweltering heat while wearing safety gear that adds to the uncomfortable conditions will drain the body quickly. You must remember to rest when you can, and when you are too tired to hold your saw safely, quit working and rest. A good time to take a breather is while your saw is being refueled and sharpened. Cramps are the body's way of telling you, it is time to rest. Often, because of the desperate situations volunteers encounter,

they will push themselves beyond their normal limits. One reason we host this school is to provide you with quality relief. Don't try to cut everything by yourself, save some for the next team that is on the way.

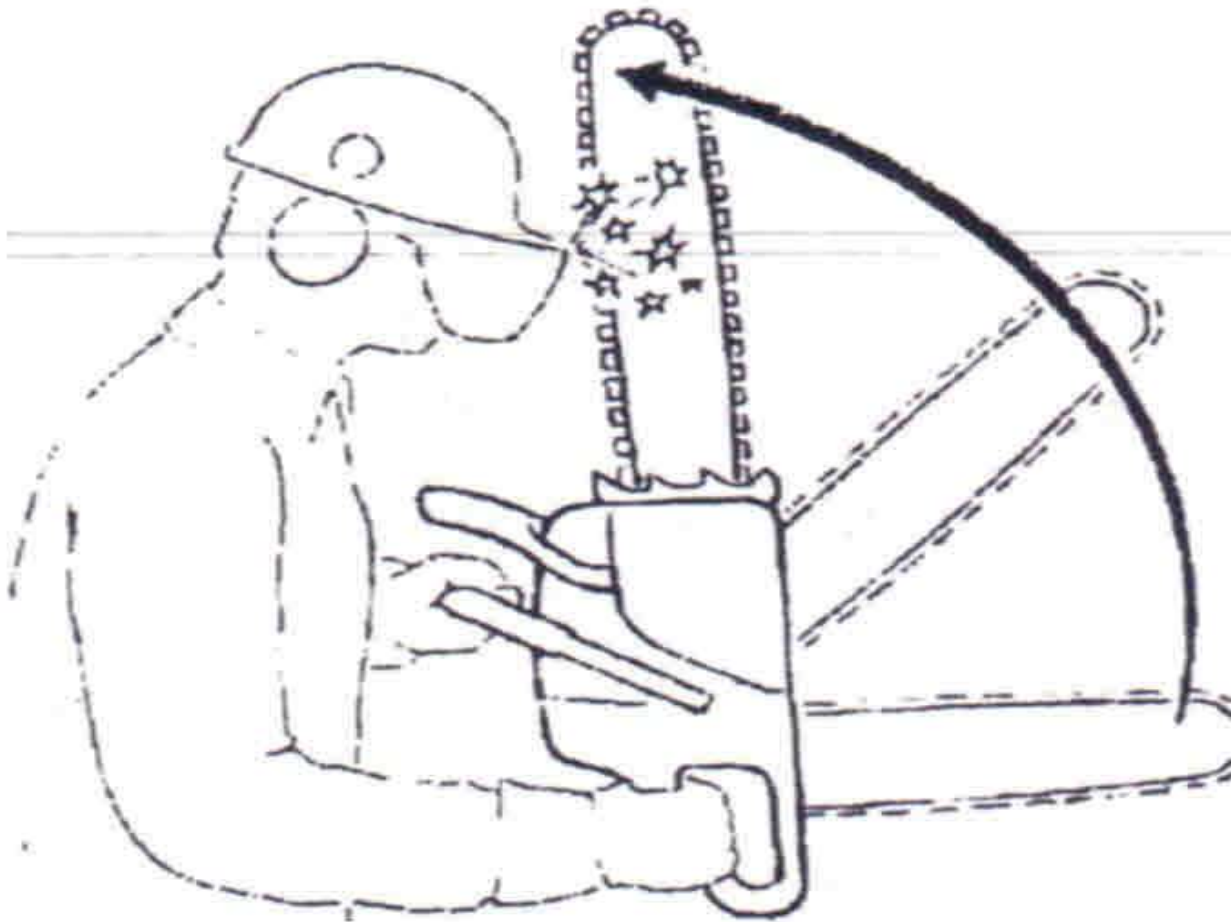

SKILL comes with knowledge and practice. Attempting to cut a tree that is beyond your skill could result in further damage to the victim's property or worse, someone may be injured or killed. You may also encounter volunteers who do not have the necessary skill or training to do even the most basic cuts. The lack of skill can cause them and you serious injury if you allow them to work with you when cutting. Tree cutting is dangerous work!

SAW CHAINS that are loose or damaged can come off the bar and cause serious damage. Kickback can lead to serious injury as well. Chains that are dull will force the operator to apply extra pressure to the saw while it is running which can also cause *fatigue* or loss of balance. Get in the habit of holding the saw to one side of your body in case of kickback or a loose chain.

"KICKBACK CAN KILL"

KILLER TREES are those trees that are inherently dangerous. Trees that are dead, rotten, or

have broken limbs can all cause problems. You must examine the complete tree before formulating your cutting plan. One side of the tree may look perfectly healthy while the backside may have a large hollow spot where you planned to wedge the tree. Broken limbs that are hanging in the tree become widow makers when dislodged by hammering on a tree wedge. Trees that are rotted may have a squatted appearance. That means that the fibers at the base of the tree have rotted and the full weight of the tree is sitting on the trunk unsupported. Plunging your saw into this kind of tree may cause your saw to be hopelessly pinched or the hinge not being able to withstand any stress thus making the tree the decision maker of where and when it will fall. Storms will also twist tree trunks and split the fibers in the tree. Consideration must be given to damaged trees before cutting.

B. THE WHOLE ARMOR

PRAYER: When the apostle Paul told the Christian to put on the whole armor of God, he implied that leaving off any piece of the spiritual armor may create problems for the believer. The same holds true for the individual operating a chainsaw. The best protection for the chainsaw team is, of course, prayer. Prayer must shadow each volunteer working in dangerous situations. Praying for safety and for opportunities to minister is the best way to start any deployment day.

HEAD PROTECTION: You were required to purchase a helmet with a face shield to attend this class.

1. The ears must be protected from the loud noise coming from the chainsaw. Several days of running a saw without ear protection can permanently damage your hearing. A note of caution must also be shared here. Since you are protecting your ears with ear *muffs*, it will be very difficult to hear someone shouting words of warning. A safety stick should be used by *your* cutting partner to warn you of danger that you may not be aware of.
2. The eyes must be protected from flying debris. Not only will you create air born saw dust, dirt that is lodged in the wood will become air born. Nails, fencing, and even bullets can be hidden in the trees you will cut. Each represents an additional hazard to your eyesight. Wear safety goggles or sunglasses under the dust shield that is attached to your helmet.

CHAINSAWS ARE FOR CUTTING TREES!

3. The head must be protected from falling limbs. Sometimes dead limbs remain hidden within the green canopy of a tree. A safety helmet must be worn by everyone on the chainsaw team at all times while in the field.

LEG PROTECTION: The majority of chainsaw accidents will strike the right thigh of the operator. With the cutting metal chain striking any part of the body, the flesh will not

be cut, but ripped and severely damaged. Chaps that are equipped with fibers that will stop the chain from moving are the only kind of leg protection that should be worn. Even volunteers who are not using the saw, but are pulling limbs will find that chaps will protect their legs from sharp branches, thorns and briars. Once chaps have been damaged by a chainsaw chain, they must be discarded.

HAND PROTECTION: The vibrations that are produced by the running chainsaw will cause the hand to fatigue. Chainsaw gloves are made to absorb the vibration. The left hand will also have fiber protection sewn into the top of the glove, it is not necessary to have it on the right hand since all chain saws are built for the right hand operation. Gloves also allow for the safe removal of limbs and vines.

C. THE REACTIVE FORCES

When the chainsaw is in operation, the moving chain creates centrifugal force that can work for the operator or against him. There are four reactive forces of the chainsaw.

1. **PULL:** If you lay the bottom of the chainsaw bar on the top of a limb, the chain will grab the wood and pull the saw away from you. You must keep a firm grip on the saw and have your feet well planted.

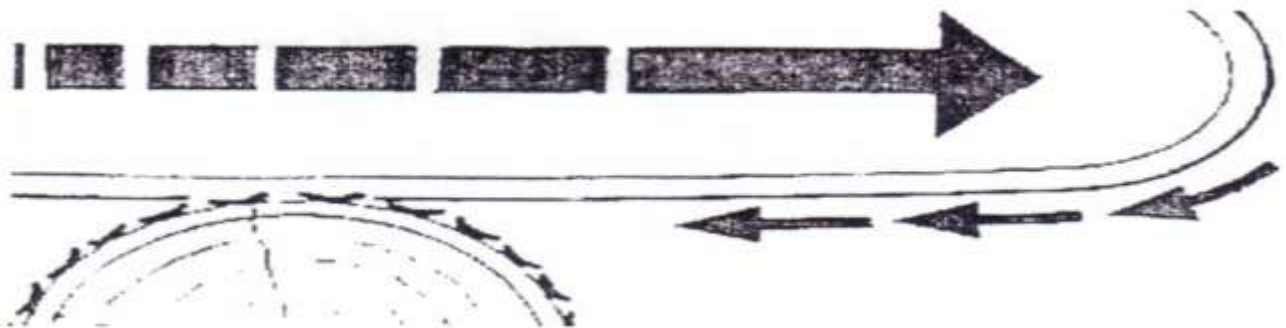

2. **PUSH:** If you press the top of the chainsaw bar underneath a limb, the saw will push itself toward the operator. Again, hold the saw firmly and keep your feet well planted.

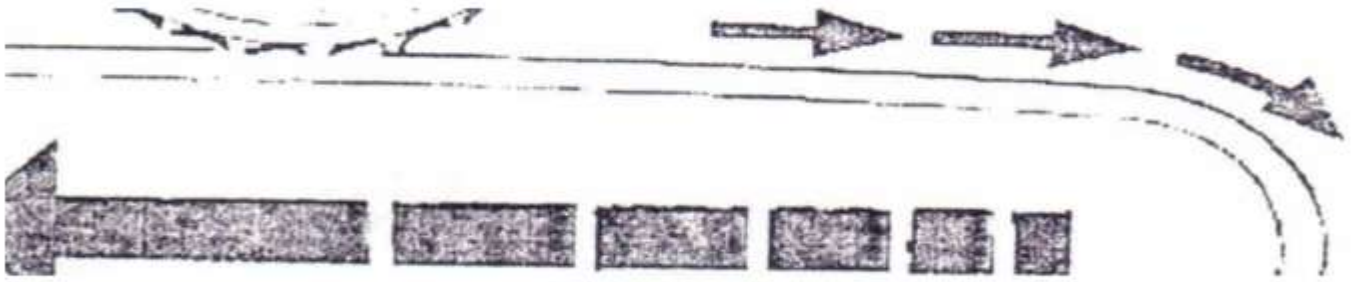

3. **ATTACK:** The bottom half of the tip of the bar is used for bore cutting and allows the operator to push the bar into and through the tree.
4. **KICKBACK:** The top portion of the bar is called the kickback and is the most dangerous part of the chainsaw. It must never be used to start a cut as it will cause the bar to jump off of the wood toward the operator.

D. JUST SAY NO:

You may be tempted to attempt to cut a limb that is out of reach. When someone suggest that you cut a limb while standing on a ladder, or in the bucket of a front end loader or on the forks of a lift, just say NO! The problem with cutting from these objects is that you have no escape route if things go wrong. Limbs can twist and knock you from the ladder or the bucket and falling limbs can hit you or the object you are balanced on, causing injury. It is not only permitted to decide that a job is too dangerous, it is just plain smart.

E. STARTING PROCEDURES:

1. **Safety Check.** Before starting your saw, check for loose or missing screws or bolts. Make sure the bar nuts are tight. Check the fuel and oil caps and the filter cover as well. Check the chain catcher. If it is missing or damage, do not use the saw.
2. **Warm-Up Procedures.** After starting the chainsaw, release the brake and depress the throttle for five seconds. (Do not pump the throttle button. You are warming a chainsaw, not a motor 'cycle.) This should be long enough to warm the engine. Set the brake, then, point the bar toward the ground, then upward and to both sides. The saw should continue to run in all directions. If not, it must be idled correctly before continuing.

3. Standing Start. There are two safe chainsaw starting methods and the drop start is never one of them. The "standing start method" allows you to place the saw handle between your legs. Engage the brake. Place the starter button on choke. Hold the handle with your left hand and pull the starter cord with your right. When the saw sputters, take the starter button off of choke and put it in the start position. Quickly snap the pull cord. When the saw begins to run, release the chain brake and run the motor at full throttle and begin your warm up procedures.

4. The Ground Start is the safest way to start your saw and may be necessary when using very heavy chainsaws. Place the saw on the ground away from any obstructions. Put the control switch, in the choke position. Place your foot inside the *flat* side of the handle. Hold the chainsaw down using your left hand on the handle. Be sure the brake is engaged. With your right hand, pull the starter cord briskly until the saw tries to start. Move the starter button to the "on" position and give the cord a brisk snap upward. Do not let the cord snap back into place as that may cause damage to the starter. Do not run the motor at full throttle with the chain brake engaged or you will damage the sprocket.

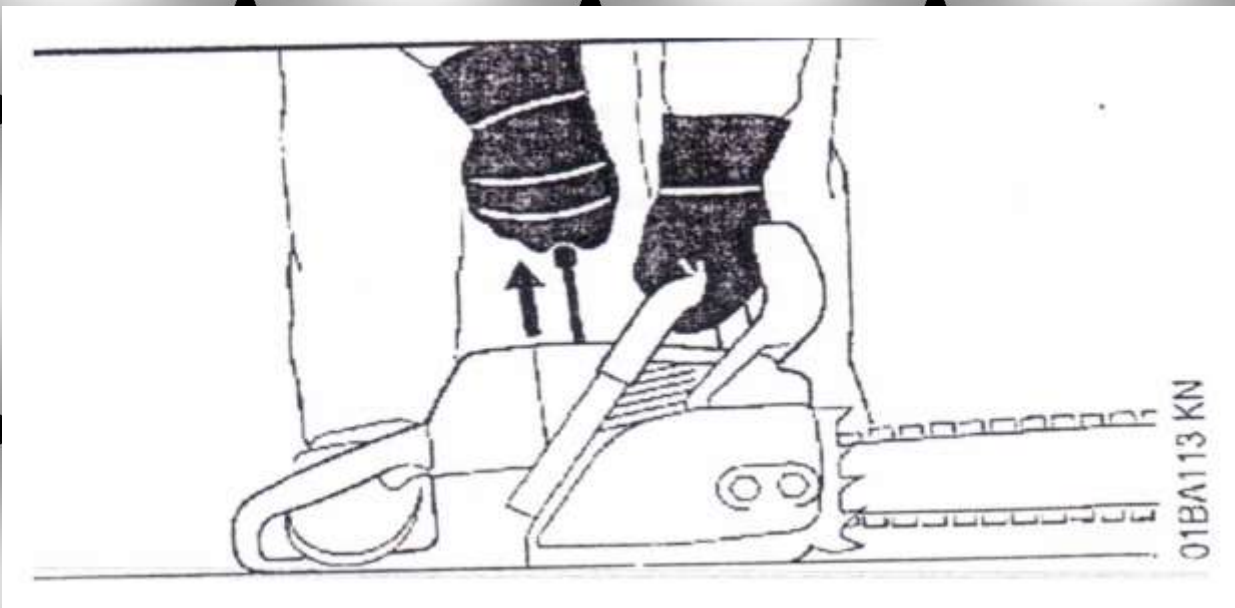

CHAINSAW MAINTENANCE

A. Visual Inspection

Before starting the chainsaw, check for loose or missing screws or bolts. Check the bar nuts to be certain they are tight. Make sure both the oil filler cap and fuel filler cap are tight. The air filter cap must also be securely attached and most important, check the chain catcher. If it is missing or damaged it must be repaired before the saw is started.

B. Air Filter

After each use the air filter must be cleaned. A dirty air filter will prevent the saw from running at full power. The filter must be removed and cleaned by brush, air or soaking. Different filters require different methods of cleaning.

C. Spark Plug

While the filter is removed it is wise to check the spark plug. A fouled plug will make the saw difficult or impossible to start. To remove the plug, pull off the spark plug boot. The plug can now be unplugged and cleaned with a dry rag. Check the electrode gap for proper setting. After setting the master control to the stop position (Stihl), crank the engine several times to clear the combustion chamber. The plug can now be refitted and after the boot has been attached the saw is ready for starting. Too much oil and a dirty air filter will cause most plug fouling problems. The spark plug should be changed after each 100 hours of operation.

D. Starter Cord

The starter cord should be checked before each use. The point of most wear is usually where the cord is attached to the pull handle. The cord should be repaired as soon as it begins to fray. To change the cord, the cover must be removed:

1. Unscrew the four screws which attach the cover to the saw's body.
2. Push the hand guard upward and pull the underside of the fan housing away from the crankcase and remove it downward.
3. Using circle pliers, carefully remove the circle.
4. Remove the washer, driver, spring housing and second washer.
5. Remove the spring clip.
6. Remove the rope rotor with washer and pawl. (The rewind spring may pop out and uncoil, be cautious).
7. Remove the cap from the starter grip.
8. Remove the remaining rope from the rotor and grip.
9. Thread the new started rope through the grip, tie a knot at the end and replace the cap.
10. Thread the rope through the top of the guide bush, pull it through the rotor and secure it with a simple overhand knot.

11. Coat the rope rotor bearing bore with resin-free oil.
12. Slip the rotor over the starter post; turn it back and forth to engage the anchor loop of the rewind spring.
13. Fit the pawl in the rope rotor.
14. Fit the washer on the starter post.
15. Use a screwdriver or pliers to install the spring clip on the starter post and engage it on the pawl's peg. (The spring clip must be pointed clockwise.)
16. Make a loop in the starter rope and use it to turn the rope rotor six full revolutions clockwise.
17. Hold the rope steady, pull out and straighten the rope.
18. Release the rope rotor.
19. Let go of the rope slowly so that it winds onto the rope rotor.
20. Adjust the tension by adding or removing a loop in the rope.
21. Fit the fan housing on the crankcase.

E. Chain Sprocket

Replace the chain sprocket as soon as it begins to show wear.

1. Use a screwdriver to remove the e-clip.
2. Remove the washer and rip sprocket.
3. Examine the splines on the clutch drum. If excessive wear is visible replace it.
4. Pull the clutch drum and needle cage of the crankshaft.
5. Clean the crankshaft stub and needle cage then lubricate with grease.
6. Push the needle cage onto the crankshaft.
7. After fitting the clutch drum, rotate it one turn to engage the oil pump drive.
8. Fit the rim sprocket with the cavities facing outward.
9. Return the washer and e-clip on the crankshaft.

F. CHAIN BAR

Turn the bar over - every time you sharpen the chain and every time you replace the chain - this helps avoid one-sided wear, especially at the nose and underside of the bar. Regularly clean the oil inlet hole (1), the oilway (2), and the bar groove (3). Measure groove depth - with scale on *filing* gauge in the area used most for cutting.

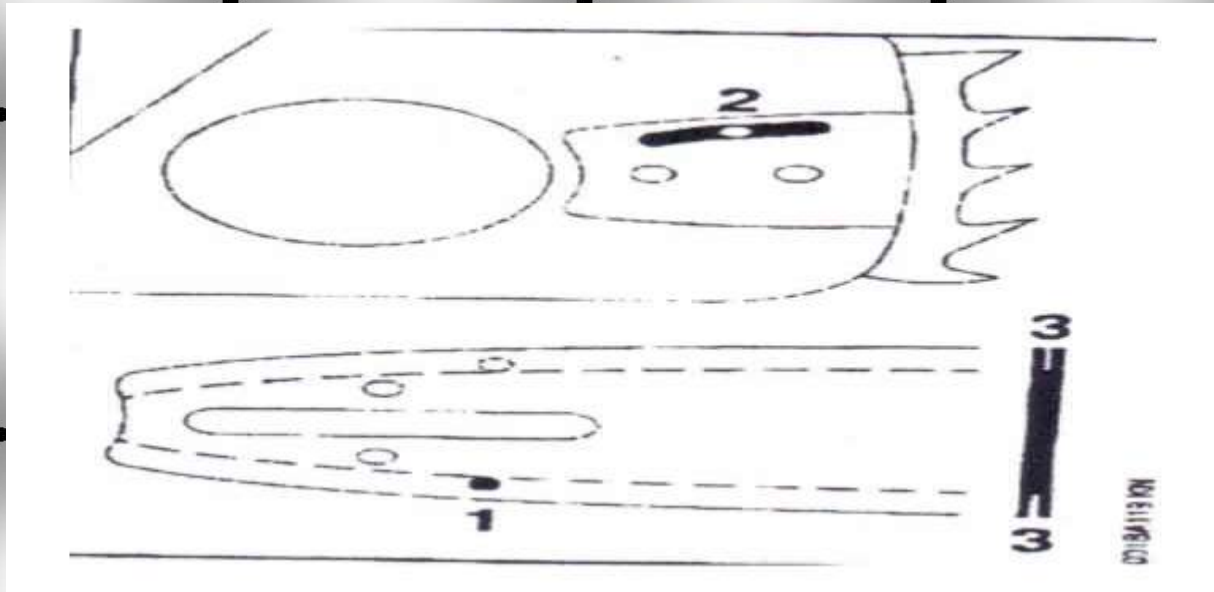

G. CHAIN

Since the chain is the most dangerous part of the saw, it must receive the most attention. The chain must be regularly inspected for cracks in the links and damaged rivets. Damaged and worn parts of the chain must be replaced. The chain pitch is marked on the depth gauge end of each cutter.

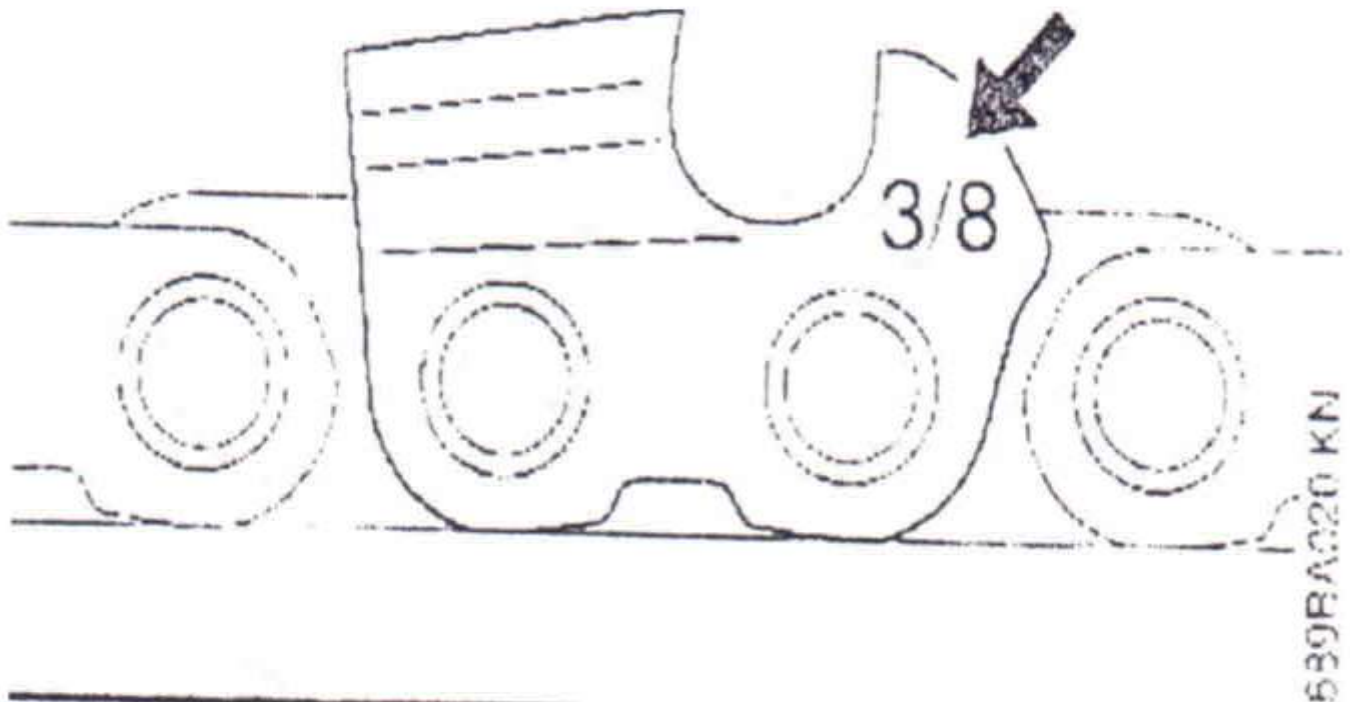

1. Use a file holder when manually sharpening a chain.
2. Lock the chain by pushing the chain brake forward.
3. While resting the file holder on the top plate and depth gauge, hold the file horizontally (at a right angle) and file according to the angles marked on the file holder.
4. Make no more than 3 strokes per link.
5. Always file from the inside to the outside of the cutter.
6. The file only sharpens on the forward stroke. Lift the file off the cutter on the backstroke.
7. Avoid touching the tie straps and back links with the file.
8. Rotate the file at regular intervals to avoid one-sided wear of the file.
9. Check the angles with the filing gauge.
10. The depth gauge must be lowered each time the chain is sharpened.
11. File down the depth gauge each time each time the chain is sharpened until it is level with the filing gauge.

12. File the top of the depth gauge, parallel to the depth service markings
13. Place the filing gauge on the chain. The highest point of the depth gauge must be level with the filing gauge.

Saw Teeth

figure 1

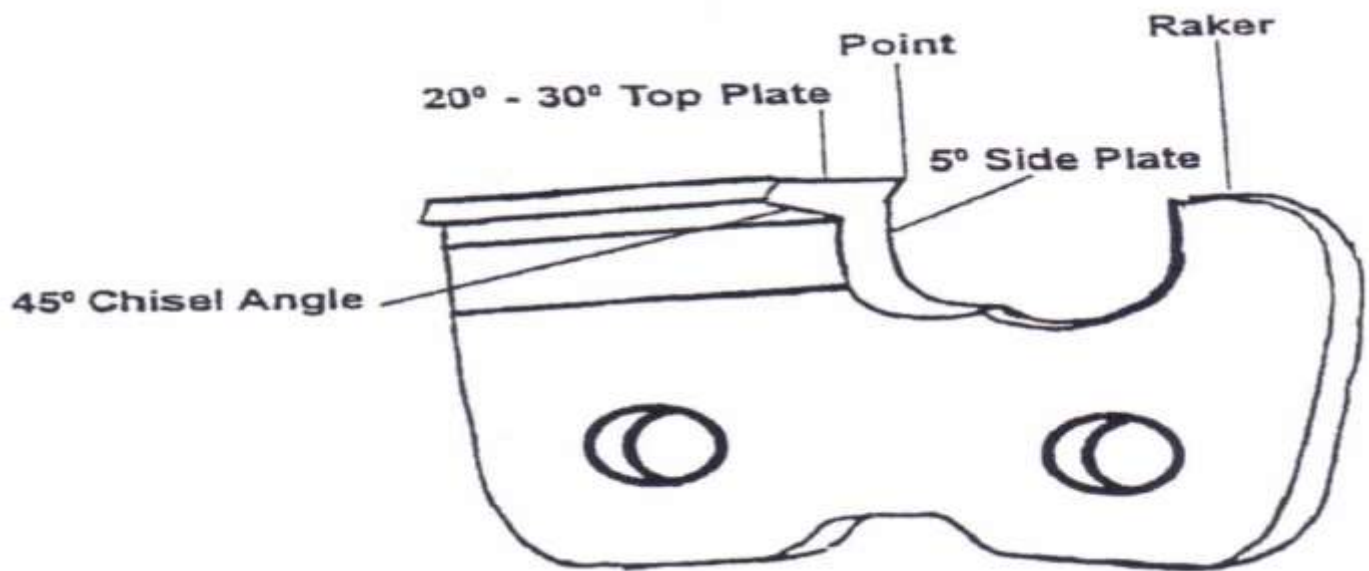

CUTTING METHODS

Most of the trees you will be cutting when deployed to a disaster site will already be on the ground. Many will also be on houses, vehicles and out buildings. The methods you are about to learn will give you the confidence and knowledge to safely drop trees that are a safety hazard. You must remember however, experience is the best teacher and your completing this class will not make you a tree cutting expert. After completing this class you need to practice what you have learned and always apply the rules of safety in every tree cutting situation.

A. Measuring the Tree.

- I. When felling a tree maintain a distance no less than twice the tree length for the nearest person, hazard, or power line.

2. If you are working near a road, stop all traffic when dropping the tree where it could twist or take an unplanned fall toward the roadway.

1. You can estimate the tree's height using a straight stick cut to the exact length of your arm. Walk away from the tree to a point where, by holding the stick vertically at arm's length, the entire tree's vertical centerline is hidden behind the stick. This method works best when you are at the same elevation as the base of the tree. Measure the distance to the base of the tree - this distance will be approximately the same as the tree's height.

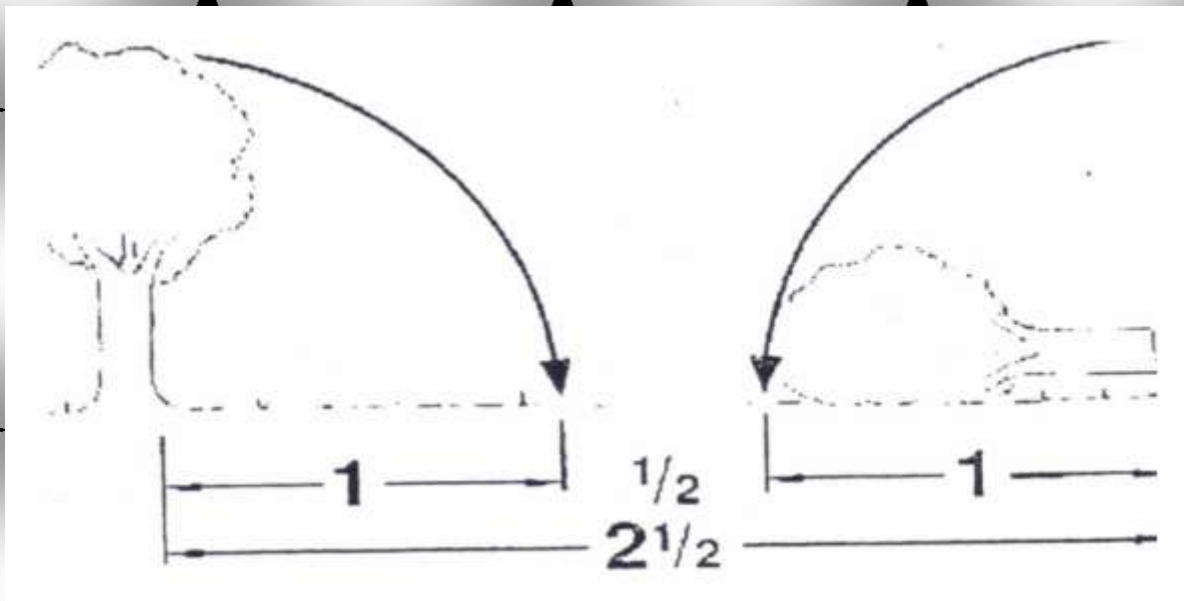

B. The Felling Plan

1. **HAZARDS:** Consider the possible hazards you may encounter while cutting the tree or during its fall. This may be a strong wind, vines, limbs from other trees, or dead limbs in the tree being cut, hollow or rotten spots.
2. **LEAN:** Determine the lean of the tree and how it will factor in the dropping of the tree. The lean may determine the felling plan, (too much to lift) or it may influence how many wedges you use. (slight lean)

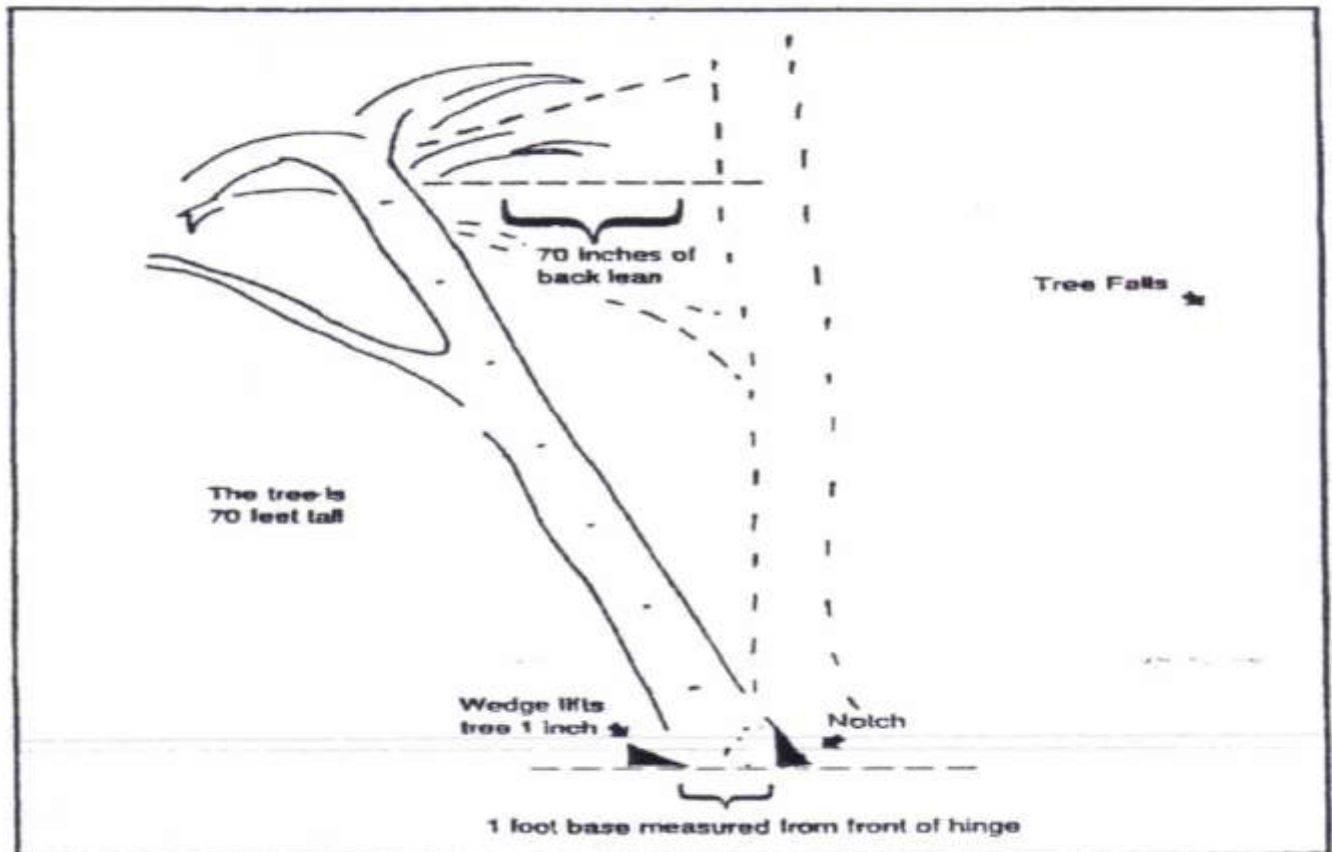

3. ESCAPE ROUTE: When the tree begins to fall, you will need two avenues of escape to get out of the danger zone. Trees have been known to shatter before they fall or bounce upon impact. You must choose a clear path that is a 45 degree angle to the rear, away from the direction of the fall. If the path is not clear, take time to clear it of branches and vines that may cause you to stumble. You should be able to move at least 20 feet from the tree you are cutting.

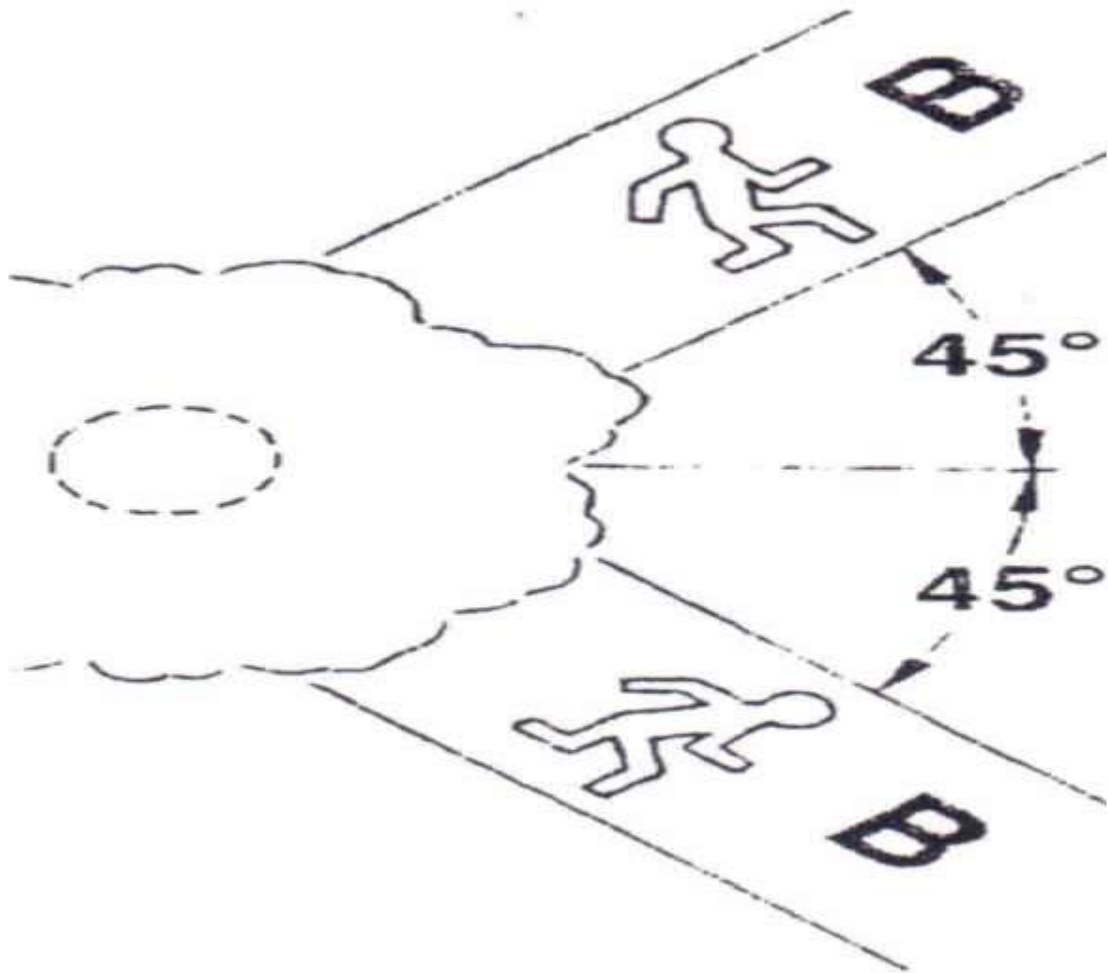

PLAN YOUR ESCAPE BEFORE YOU CUT

4. FACE CUT: The positioning of the face cut will normally determine where the tree will land. The face cut should form a notch that is 70-80 degrees. The width of the notch should be 80% of the diameter of the tree. The hinge cut is then made and should be approximately 10% of the tree's width. Remember that the hinge is what holds the tree upright until it is broken by the wedges.

Cut A

Cut C



36

When making the felling notch, use the gunning sight on the shroud and housing to check the required direction of fall:

Position the saw so that the gunning sight points exactly in the direction you want the tree to fall.

Gunning Sight

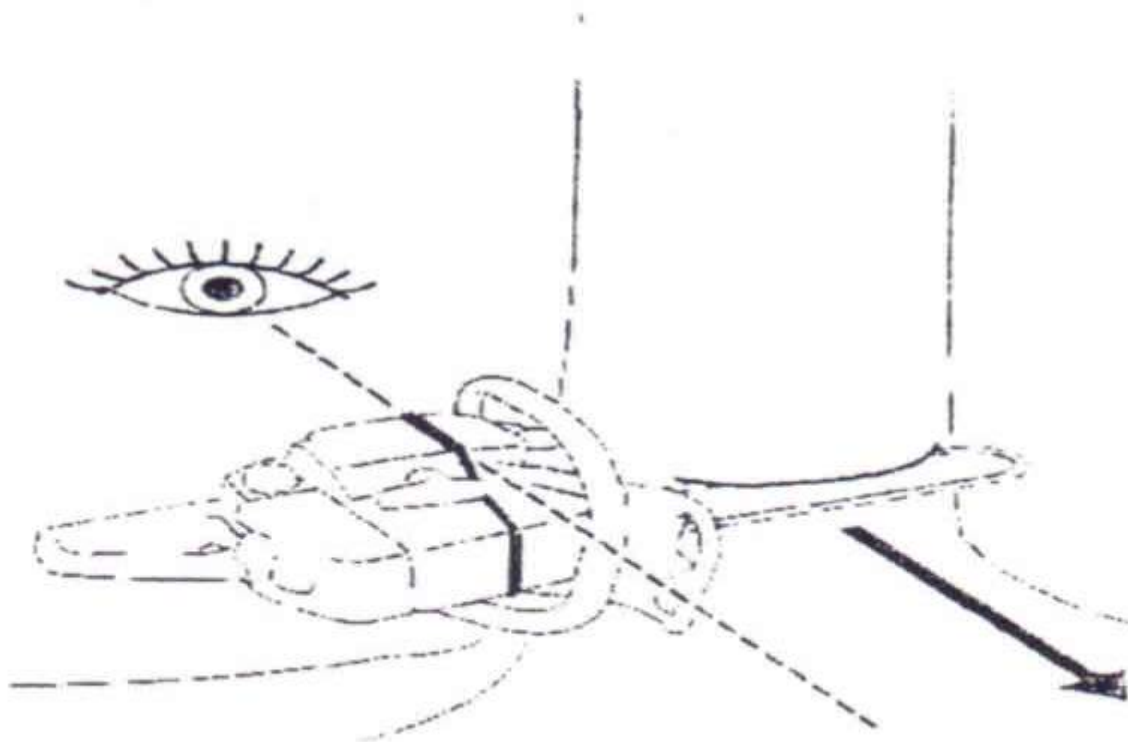

5. BACK CUT: The back cut is determined by the size of the tree and the lean. You will need to determine what side of the tree is the bad side and how you will lift the tree to break the hinges.

C.SEGMENTS: To determine if a tree with back lean can be felled using wedges you need to know how many segments are in the tree. A segment is a square whose side is equal to the distance measured on the stump of the tree from the front of the hinge to the back of the tree. This distance, rounded to the nearest feet, forms the sides of the square for a segment in that tree. To determine the total number of segments, divide the height of the tree by the dimension of one segment. For example, a 70 foot tree with a 12" diameter will have 70 segments. We know that lifting the bottom of one segment moves the tree top over one inch as well. Therefore, if the tree has 70 segments the top of the tree will be moved 70". A tree with a back lean of less than 70" can be felled with one wedge.

D. BORE CUT: A bore cut is used to fell large trees.

1. Cut, using the bottom portion of the guide bar tip, until the depth is equal to the width of the guide bar and deep enough to stop kickback.
2. Operating at full throttle, align the saw with the direction of the cut.
3. With the saw still at full throttle, press the guide bar straight into the trunk.
4. Use appropriate wedges to fill in where you have cut until you are ready to break the hinge.
5. The hinge is that strip of tree that is not cut that is equal to 10% of the diameter of the tree and is adjacent to the face cut.
6. A face bore will begin at the center of the face cut.
7. The side bore will begin at one side of the tree and run parallel with the face cut.

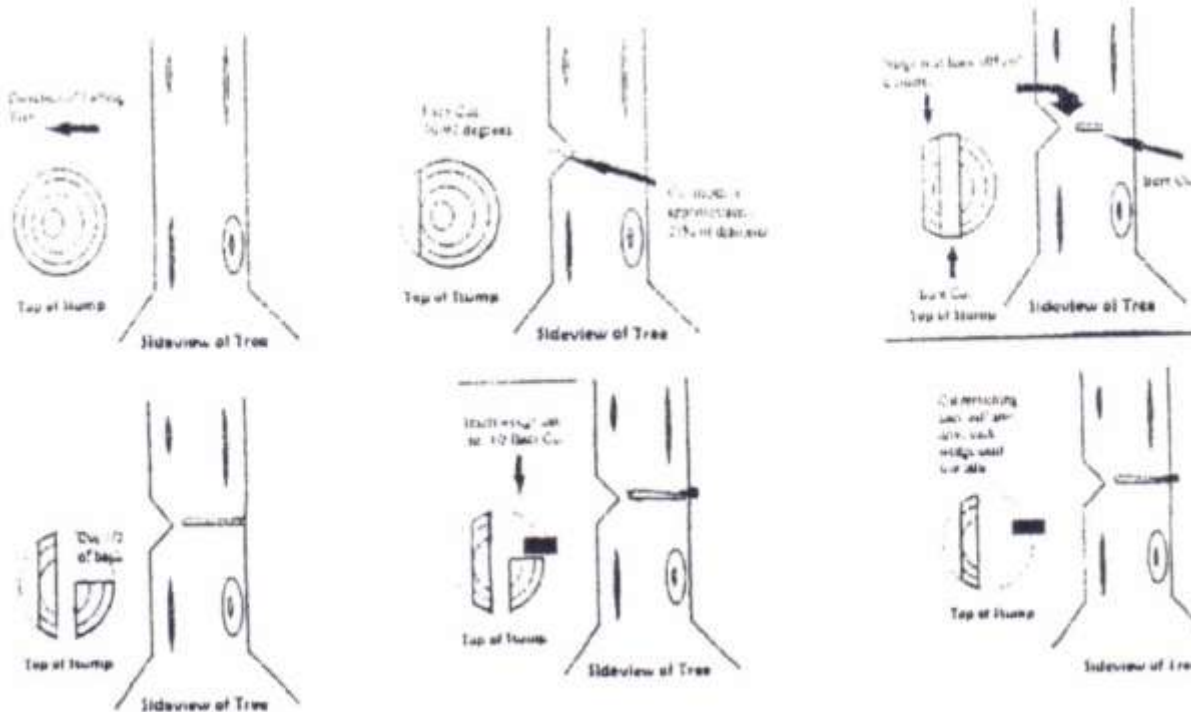

E. SPRING POLES: Spring poles are trees and/or large limbs that have been trapped by larger trees or limbs. The trapped trees (spring poles) stored energy and can pose a serious threat to the cutter when released. To determine the safe cutting position for a spring pole, imagine a horizontal line running parallel with the top of the arc. Imagine also a vertical line running parallel with the tree's trunk. From the intersection of these two imaginary lines, come down at a 45 degree angle and where the line meets the tree is where the tree should be cut. The saw should be lowered slowly but at full throttle into the tree with the cutter standing at a 45 degree angle from the direction of the fall. A tall spring pole must be released from the underside.

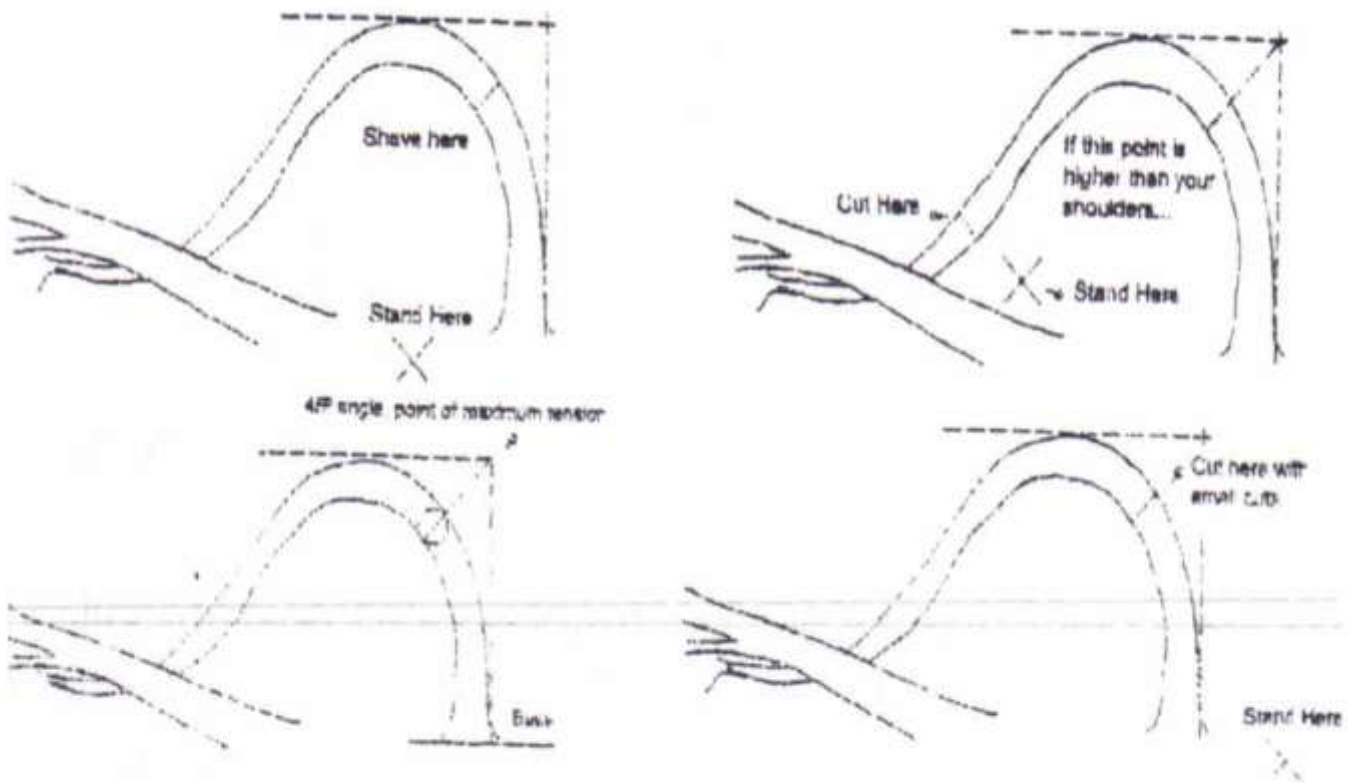

F. LIMB REMOVAL: Removing limbs from fallen trees can still represent safety hazards. A large limb vertical to the trunk can be removed using the open face method previously discussed. Small limbs can be cut using the bypass cut, so that all fibers running along the limb are severed. A limb that must be removed from the trunk can be removed by making an initial compression side cut and then going to the backside and cutting until the limb moves.

If removing an entangled limb and you wish to avoid rolling, use the tongue and groove cut. To make a tongue and groove cut, make a plunge cut through the limb at the halfway point. Make a second cut on the compression side, four to six inches above the plunge cut. The cut should stop parallel with the plunge cut. This severs the lengthwise fibers and allows the limb to be removed while under complete control. This method may also be used when a log is spanning a ditch or other logs.

NOTCH COMPRESSION - CUT THROUGH TENSION

Logs tinder strain: Risk of pinching! Always stall relieving cut (1) at compression side (A). Then make bucking cut (2) at tension side (B). If the saw pinches, stop the engine and remove it from the log.

COMPRESSION VERSES TENSION

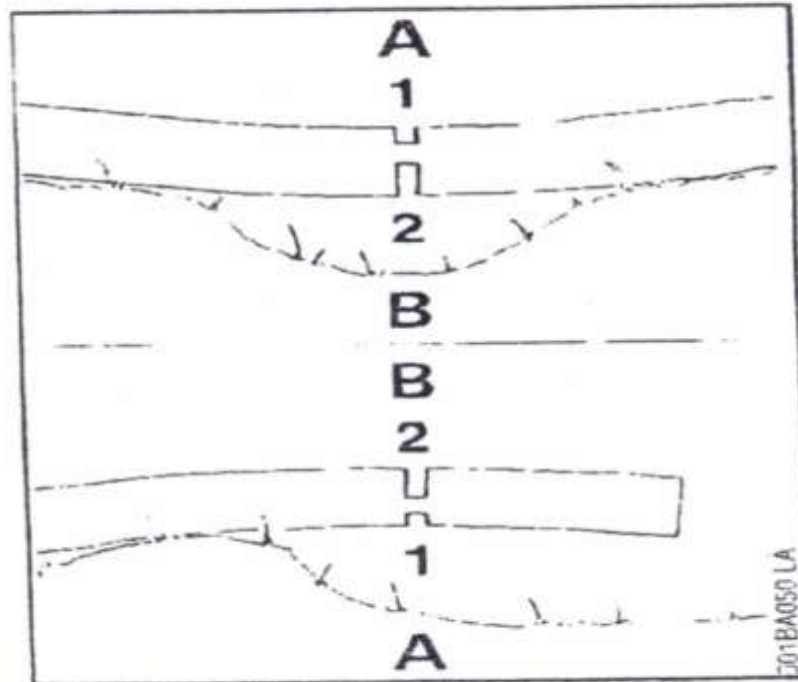

NOTCH COMPRESSION - CUT THROUGH TENSION

G. **POLE SAWS:** Overhead limbs and branches can be safely removed by using a pole saw. The rule to remember is to always knock the compression side of the limb first, then cut through the tension side. When your pole saw becomes pinched overhead, you will need to use a second pole saw to release the compression or tension to free the saw. Keep that in mind, if your Unit only has one pole saw.

H. **LIMB LOCK:** Back and sideways pressure on limbs can be handled using a limb lock. If limbs have back pressure on them, they can severely injure an operator when they are severed from the tree. A good precaution to use in these circumstances is a limb lock. The purpose of a limb lock is to prevent a limb under pressure from kicking back and striking the leg or pinching the saw. The first cut is made on either the top side or bottom side of the limb (top and bottom refer to top and bottom of the limb as if the tree were standing up.) It is preferable to make the first cut on the side with compression pressure and the second cut on the side with stress.

The cut on the top of the limb is made closer to the trunk of the tree and the cut on the bottom is made further out on the limb. It is important that the two cuts by-pass so that all fiber is severed. This will create a step in the limb which will prevent the limb from kicking back and hitting the operator. This is similar to the way in which a raised back cut prevents the butt of a tree from kicking back over the stump.

I. TOP LOCK: Twisting of trees and butts off the ground create pressure on the stem that can be handled with a top lock. If the stem of the tree is under stress, a top lock can be used to prevent the top from kicking up and striking the operator. The first cut of a top is made on the side of the tree that is under compression, in the top or bottom of the stem. The second cut is made on the sides of the tree which is under tension. This prevents pinching the saw. The top cut is always made closer to the top of the tree and the bottom cut is made closer to the bottom of the tree (the reverse order of the limb lock.) Both cuts must by-pass so that all fiber is severed.

If there is danger of a tree or portion of a tree rolling on the operator, a tongue and groove can be used. To make the tongue and groove, the stem of the tree is bored in the center. Then up and down cuts are made either closer to the top or butt of the tree so that each of them by-passes the bore cut, but do not meet. With all fibers severed, the tongue and groove will prevent the tree from rolling.

Generic Rules for piling debris

- 1) Keep trash piles away from mailboxes, light poles, fire hydrants, water/gas meters, and power lines because that makes it harder to pick up.
- 2) Although it is best if you don't put trash piles in ditches because not only is it hard for trucks to gather the material and it creates drainage problems, there may not be an alternative spot. Be sure to survey the area and put the trash in the best possible place for pickup.
- 3) Make sure the pile only contains green/tree materials and not other items such as bagged items, tires or building materials. Most waste companies will not pick up piles with mixed debris